

data sheet:

FILCOTEN one NW150

D400 - F900kN, Typ M

Rinnen/Channel:

FILCOTEN one NW150

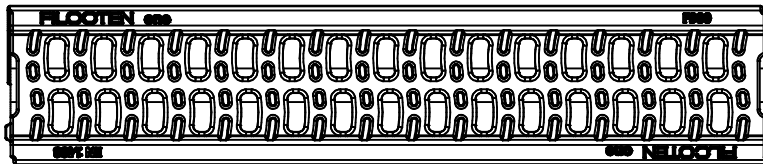
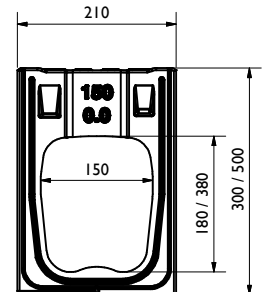
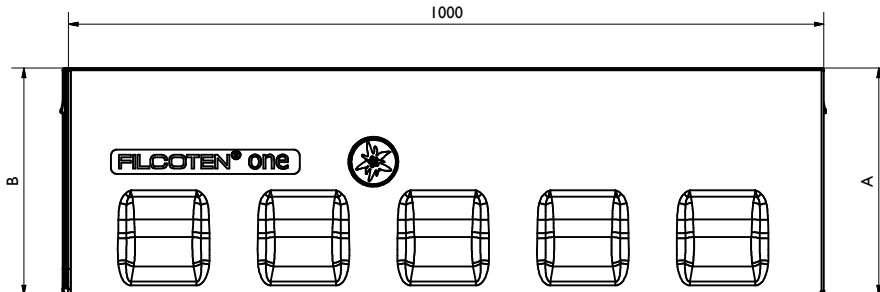

Rinne / channel - Maße / dimensions [mm]						
BG code	Typ	Höhe A height A	Höhe B height B	Länge length	Einlaufquerschnitt [cm ² /m] inlet cross section [cm ² /m]	Gewicht [kg] weight [kg]
15015100	0	300	300	1000	370	76,6
15015168	40-0	500	500	1000	370	107,5

Revisionselement / Maintenance Unit

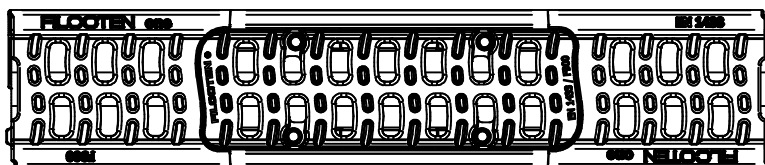
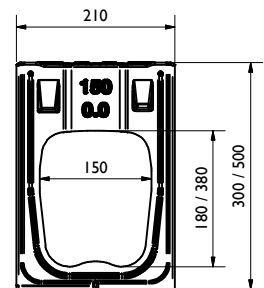
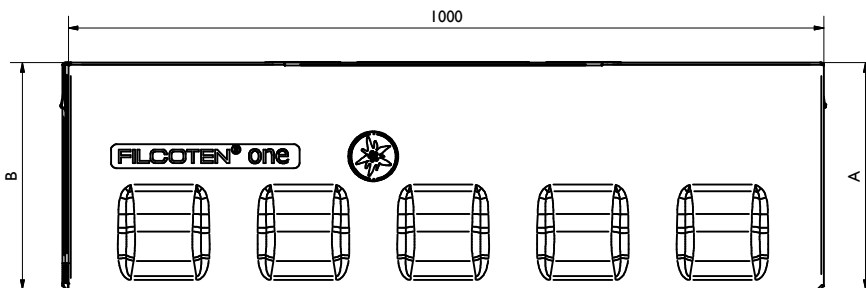

Revisionselement / Maintenance unit - Maße / dimensions [mm]						
BG code	Typ	Höhe A height A	Höhe B height B	Länge length	Gewicht [kg] weight [kg]	
15015180	0	300	300	1000	79,5	
15015188	40-0	500	500	1000	108	

data sheet:

FILCOTEN one NW150



D400 - F900kN, Typ M

Ablaufelement / Outlet Unit

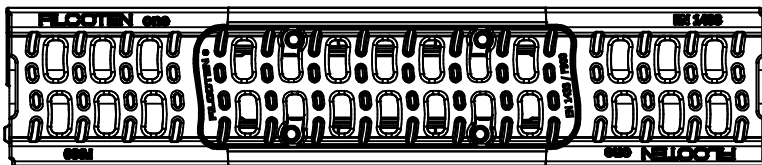
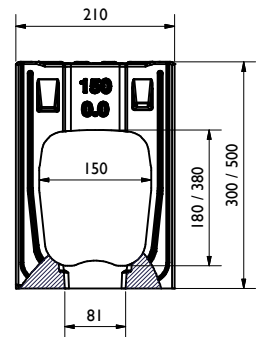
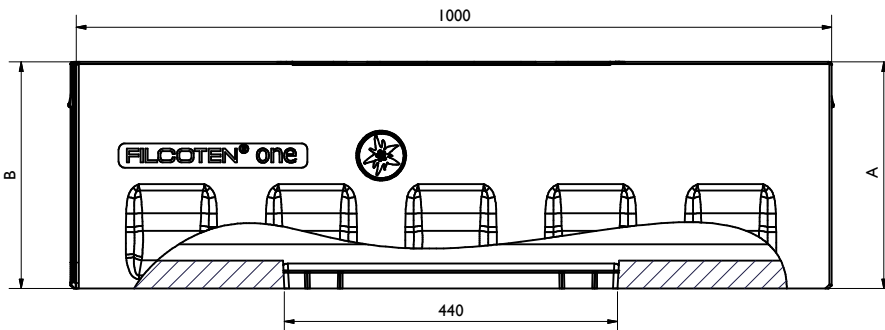

Ablaufelement / Outlet unitl - Maße / dimensions [mm]					
BG code	Typ	Höhe A height A	Höhe B height B	Länge length	Gewicht [kg] weight [kg]
15015170	0	300	300	1000	76,8
15015178	40-0	500	500	1000	105,4

data sheet:

FILCOTEN one NW150



D400 - F900kN, Typ M

Ablaufelement Unterteil / Outlet-unit base-part

BG code: 19115095; 32,8kg

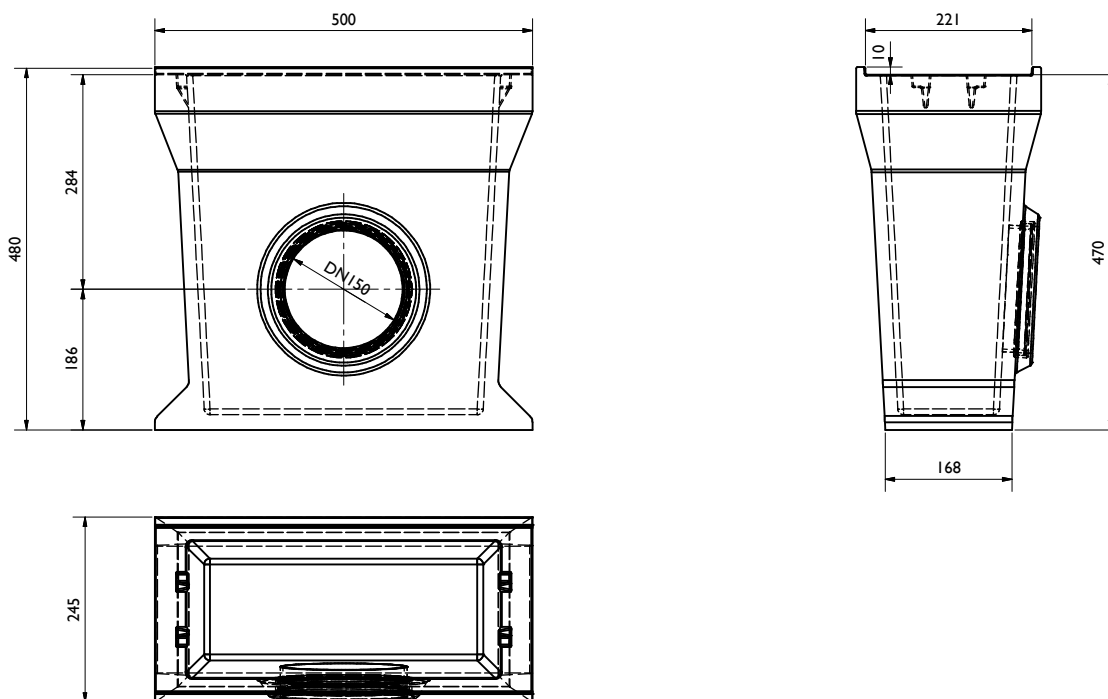

Schlammmeimer / Silt bucket
(optional für Ablaufelement / for outlet unit)

BG code: 22510 (PVC); 0,5kg

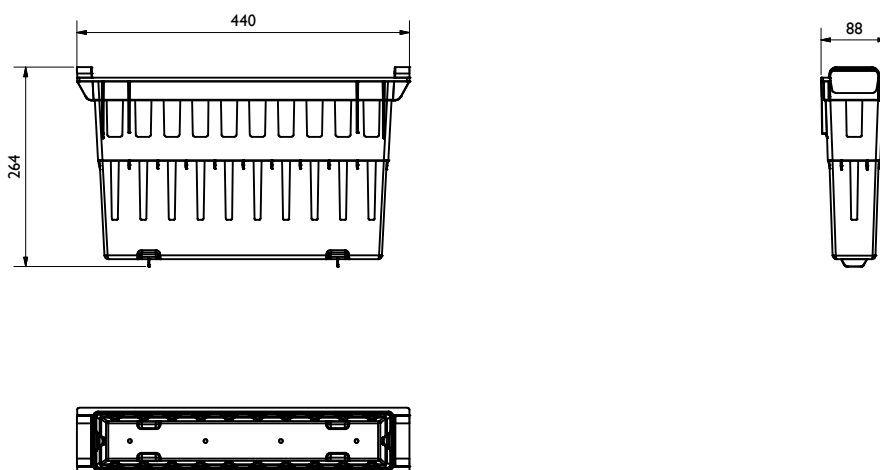

data sheet:

FILCOTEN one NW150



D400 - F900kN, Typ M

Zusammenbau Ablaufelement inkl. Schlammweimer / Assembly outlet unit inkl. silt bucket

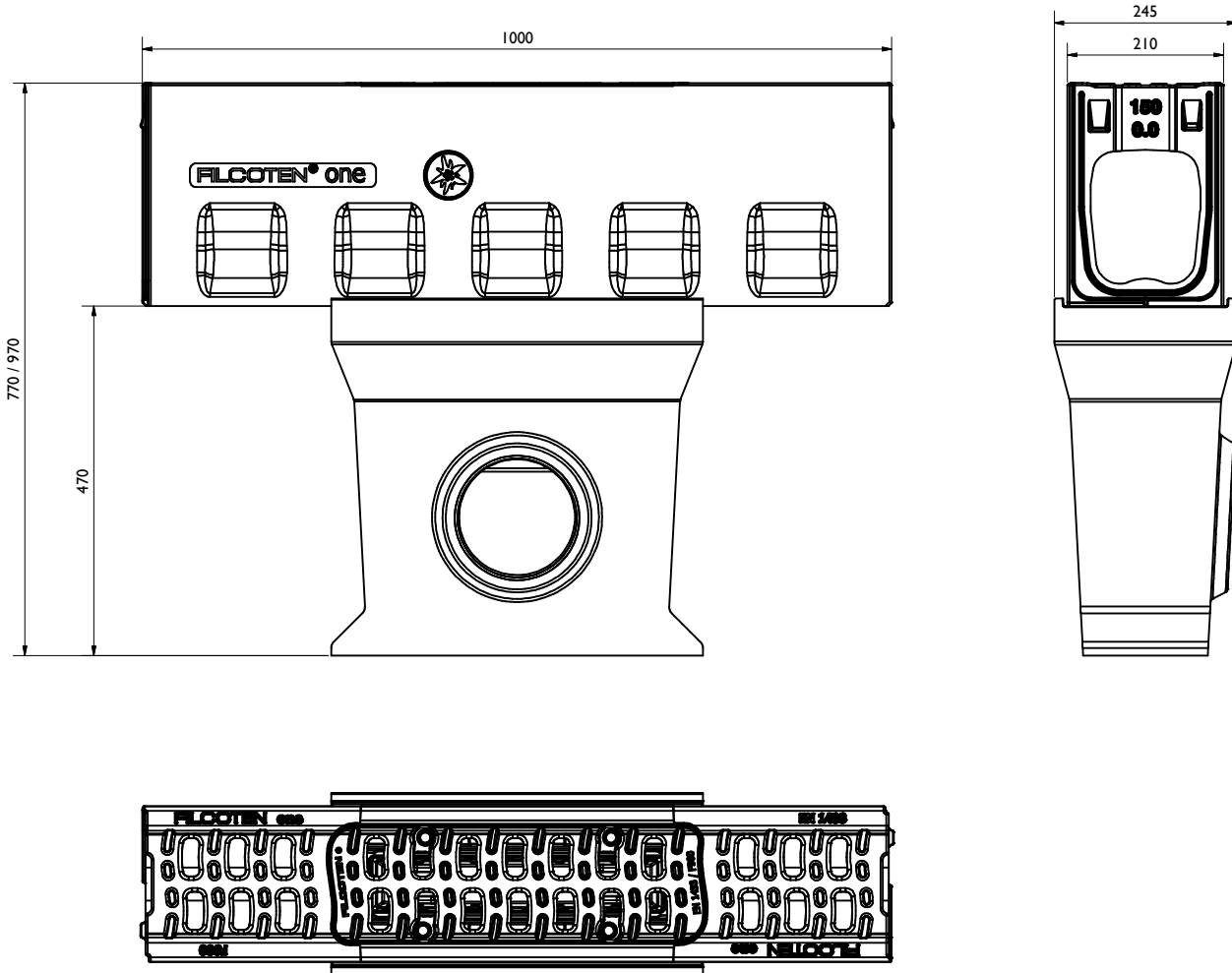

data sheet:

FILCOTEN one NW150



D400 - F900kN, Typ M

Endplatte (mit Ablauf) / Endplate (with outlet)

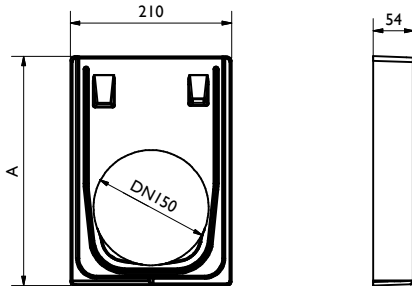

Stirnplatte (ohne Ablauf) / Frontplate (without outlet)

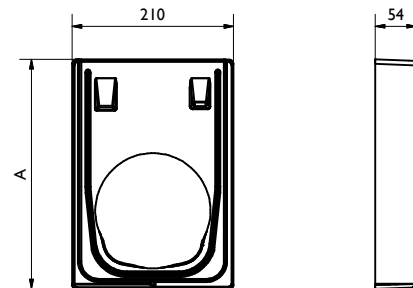

Endplatte (mit Ablauf) / Endplate (with outlet) - Maße / dimensions [mm]				
BG code	Typ	Höhe A height A	Durchmesser diameter	Gewicht [kg]
19115110	0-0	300	150	5
19115118	40-0	500	150	10

Stirnplatte (ohne Ablauf) / Frontplate (without outlet) - Maße / dimensions [mm]			
BG code	Typ	Höhe A height A	Gewicht [kg]
19115100	0-0	300	7
19115108	40-0	500	12

Verbindungsplatte für Stufenversetzung / Connectorplate for stepped fall Nr.0 / 0-40

BG code: 19115157; 9kg

Ansicht / view A

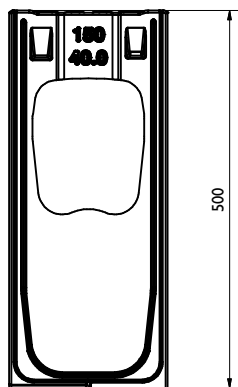

A →



← B

Ansicht / view B

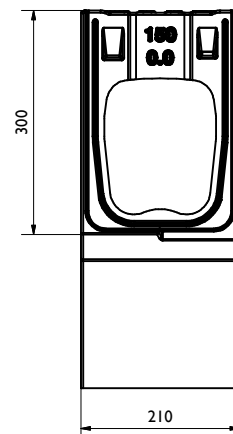

Dichtungsprofil / sealing-profile
(optional)